

P5BOOTER Instruction manual

Contents:

I. Product introduction

II. Use of PS5/PS5 console

III. Use of NS console

IV. Use of PC

V. COOV Manager(PC)

VI. Booting Mode

VII. Updating of firmware/macro functions

VIII. button spirit

8.1 Button position mapping

8.2 Running fire

8.3 Button combo

8.4 Learning function (indefinite loop)

8.5 Joypad vibrating adjustment

8.6 Switching four groups of independent configurations

8.7 Start shooting-force gun

8.8 Force gun without start shooting

I. Product introduction

P5BOOTER can use the third-party joypad on PS5/PS4/Switch/Switch Lite/PC console and has the functions such as force gun, button position mapping, running fire, learning, etc.

bluetooth connection

Indicator status

The indicator light is off: not paired

Blue Light blinking: Pairing

The Blue indicator light is always on: the pairing is successful

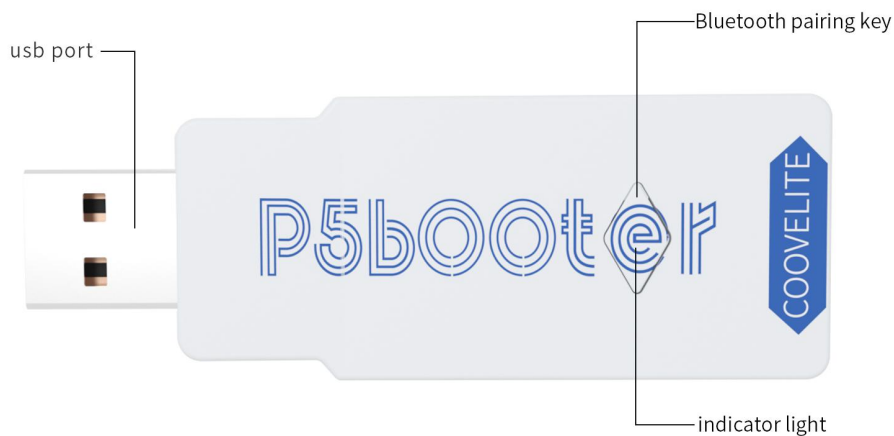

II. Use of PS5/PS4 console

There has 2 way to run PS5 game

Method A:

P5BOOTER insert into PS5/PS4 console usb port, and connect joypad with bluetooth.

bluetooth connection

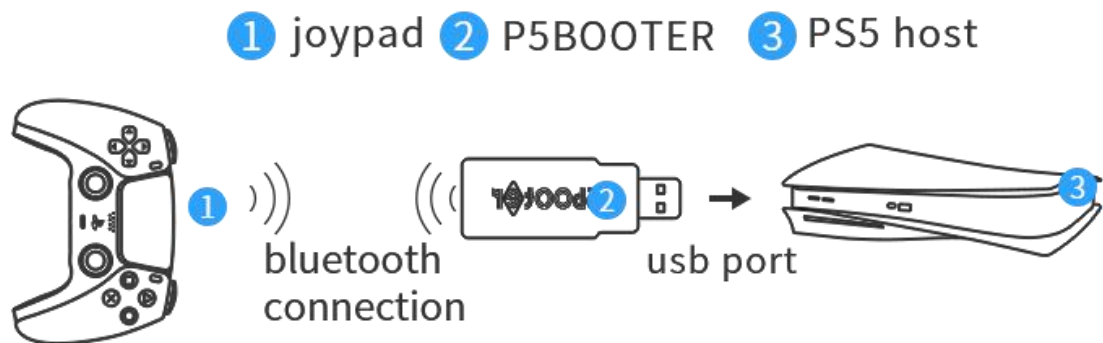

Set up the console before use

1: To disconnect the Bluetooth of the original PS5/PS4 joypad, the method is: "Settings-Peripheral devices-Bluetooth devices-find the corresponding controller to disconnect" (or use a different PS5/PS4 account after connecting the P5BOOTER)

2. Insert P5BOOTER into the USB port of the PS5/PS4 console according to the schematic diagram, and press the pairing button, so that the blue light of the indicator light quickly flickers (Bluetooth searching status)

3. Press the pairing button of the joypad (refer to the pairing description of the joypad below) until the joypad is in the Bluetooth searching status.

4. Wait for about 3 to 5 seconds, the joypad indicator light is always on, P5BOOTER blue indicator light is always on, and at the moment the Bluetooth pairing connection succeeds. Press the joypad Home button, so the joypad can normally control the PS5/PS4.























Pairing description of the joypad

Bluetooth pairing of the PS5/PS4 joypad: long press the button "SHARE + PS" , and the joypad indicator light double flashes.



Bluetooth pairing of the X1S joypad: long press the button "BACK + X" , and the joypad indicator light quickly flickers.

NS Pro joypad Bluetooth pairing: long press the button  at the top of the joypad, and the indicator light below the joypad circularly flickers.

X1 and switch Pro handle simulate ps5 / PS4 handle touchpad as follows:

Touch pad function	XBOX joypad	NS PRO joypad
Touch pad Click	Double click 	Double click 
Touch pad left click	Hold  + 	Hold  + 
Touch pad right click	Hold  + 	Hold  + 
Touch pad slide	Hold  + moving Rstick	Hold  + moving R-stick
Slide the touchpad and click	Hold  + moving R-stic and press down	Hold  + moving R-stic and press down
PS4 game recording	Hold  + double tap 	Hold  + double tap 
SWITCH screen capture button 	Hold  +  Or click 	PS4 joypad touch pad pressed

Notice :

To use the analog touchpad function immediately after setting the macro function, you need to exit the macro function. (Method: Hold  /  /  for 5 seconds)

Method B to run PS5 game:

1: Enter the official playstation web to download and run PS Remote Play software.

<https://remoteplay.dl.playstation.net/remoteplay/lang/ct/index.html>

2: Plug P5booter to PC USB port(windows system), pair the joypad and work.

III. Use of NS console

P5BOOTER can use the third-party joypad on Switch console/Switch lite console and is plug-and-play.

Before the use:

1. Please enter NS console "setting" - "joypad and sensor" - " wired connection of Pro joypad", and set the wired connection of Pro joypad to be on



2. Enter NS console "setting" - "joypad and sensor" - "disconnected to the joypad" (as shown in the following image)



bluetooth connection

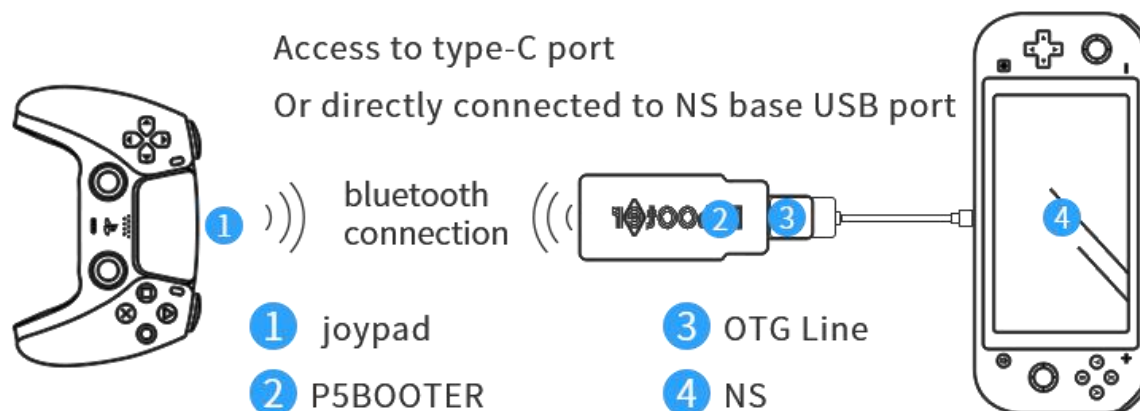

1. Enter the "joypad"- "Change Grip/Sequence" interface of the N-Switch console.
2. Insert the P5BOOTER into the TYPE-C interface (charging port) of the N-Switch console through the OTG line conversion according to the schematic diagram.Or plug into the USB port of the N-Switch base, at this time the P5BOOTER blue indicator flashes and it is in the Bluetooth pairing state.
3. . Press the joypad pairing button (refer to the joypad pairing description) until the joypad enters the Bluetooth searching status.
4. Wait for about 3-5 seconds, the joypad indicator is always on, and the P5BOOTER blue indicator is always on. At this time, the Bluetooth pairing connection is successful, and the N-Switch console can be controlled normally.

※ If the connection and pairing is unsuccessful, the blue indicator light of the P5BOOTER will go out, and you need to manually press the Bluetooth pairing button of the P5BOOTER and repeat the above steps.

Pairing description of the joypad

Bluetooth pairing of the PS5/PS4 joypad: long press the button "SHARE + PS" , and the joypad indicator light double flashes.

Bluetooth pairing of the X1S joypad: long press the button "PS + X" , and the joypad indicator light quickly flickers.

NS Pro joypad Bluetooth pairing: long press the button "PS" at the top of the joypad, and the indicator light below the joypad circularly flickers.

PC console use

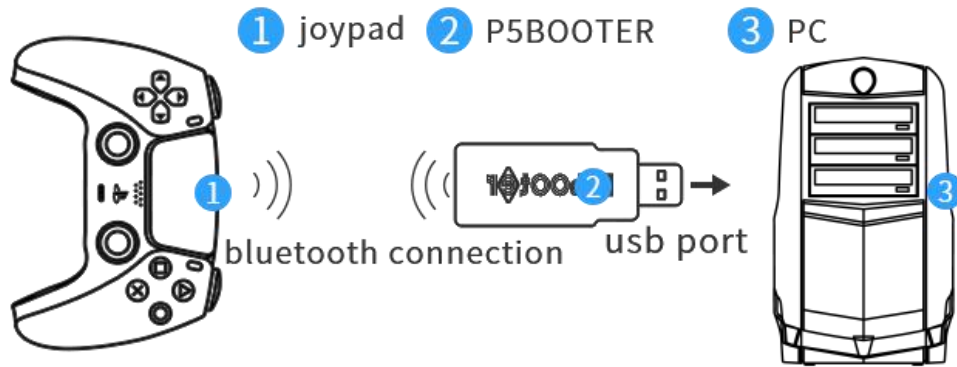

1. Enter the "Control Panel"->"Devices and Printers" of the Windows system.
2. Insert the P5BOOTER into the USB port of the PC console according to the schematic diagram, and the Wireless controller icon appears on the "Device and Printer" interface of the Windows system.
3. Make sure the P5BOOTER blue indicator flashes and it is in Bluetooth pairing status.
4. Press the joypad pairing button (refer to the joypad pairing description) until the joypad enters the Bluetooth searching status.
5. Wait for about 3-5 seconds, joypad indicator is always on, and the P5BOOTER blue indicator is always on. At this time, the Bluetooth pairing connection is successful.
6. Right-click the Wireless controller icon on the "Devices and Printers" interface, and select "Game Controller Settings"->"Wireless controller "->"Properties".
7. At this time, it will jump to the joypad button test interface to test the joypad buttons.

※ If the connection and pairing is unsuccessful, the blue indicator light of the P5BOOTER will go out, and you need to manually press the Bluetooth pairing button of the P5BOOTER and repeat the above steps.

How to reconnect the ps5 / PS4 console without unplugging the p5booter:

1. Press ps5 / PS4 console power button.
2. Press the "home" button of the handle, and wait for the automatic pairing to succeed.

Pairing description of the joypad

Bluetooth pairing of the PS5/PS4 joypad: long press the button "SHARE + PS" , and the joypad indicator light double flashes.

Bluetooth pairing of the X1S joypad: long press the button "SHARE + X" , and the joypad indicator light quickly flickers.

NS Pro joypad Bluetooth pairing: long press the button "PS" at the top of the joypad, and the

indicator light below the joypad circularly flickers.

V. COOV Manager (PC)

This software enables COOV products to be more convenient and faster to set, including the functions such as button changing, macro functions, updating, restoration, sharing, etc. Users can download this software from the download page of the website www.mycoov.com and can use this software according to relevant instructions.

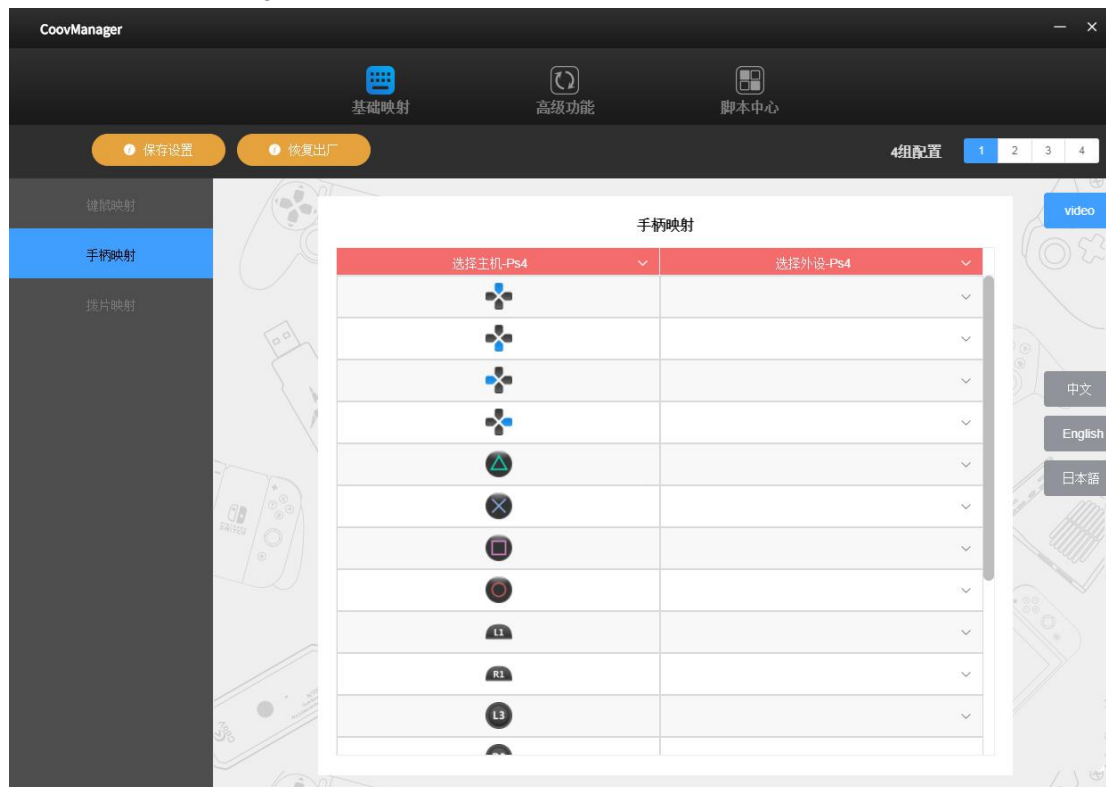

Booting Mode

- 1: Insert P5BOOTER into the-third converter USB port, hold pair button 5s till the lighting color turn into green. Now PS5BOOTER can be booting tool to support other converter running PS5 game. (Require those converter has booting function to run PS5 game)
 - 2.Exiting the Booting Mode, insert into any USB socket to get power, and hold pair button 5s till the lighting color turn into blue. Now PS5BOOTER is joypad receiver.
-

VII. Firmware/macro function updating

1. Go to the official website www.mycoov.com, "Download"- "COOV Manager (PC)", download the official software.



2. Press and hold the Bluetooth pairing button of the P5BOOTER, insert the P5BOOTER into the USB port of the computer, and release the P5BOOTER upgrade disk.
3. Open the [COOV Manager] software downloaded by the computer, click [Script Center]-[Firmware Center], select the latest firmware and click Update.



VIII. button spirit



Note 1: The same button position cannot simultaneously activate one-button running fire, one-button combo and one-button indefinite loop functions.

Note 2: In the function configuration process, every effective operation will trigger one vibration of the joystick.

Note 3: It is default that the simulation of the button  of the NS joystick/ button  of the PS5/PS4 joystick by double clicking the button  of the X1 joystick.



A. button position mapping

The button position mapping is to map one button to another different button, which can realize that a plurality of buttons are identical in function or a plurality of buttons can be interchanged in functions.

PS: Press and hold the X1  button / NS handle  button / PS5/PS4 handle  button (handle vibration feedback) for 5 seconds before setting. Turn on the macro setting switch, if you open it before, you do not need to repeat this operation.

1. Setting





- a. Simultaneously press the PS5/PS4 joystick buttons  and , X1 joystick buttons  and

 and NS Pro joystick buttons  and , and release the buttons to enter the button position mapping function configuration mode.







b. Press the button to be mapped.

c. Press the target-mapping button.

d. Press the PS5/PS4 button /X1 button /NS Pro button  to exit the configuration mode.

For example, first press the button  and then press the button , so that the button  has the function of the button .



Individual cleanup

a. Simultaneously press the PS5/PS4 joystick buttons  and , X1 joystick buttons  and , and NS Pro joystick buttons  and  to enter the button position mapping function configuration mode.







b. Press the button with the mapping to be cleaned up.



c. Press the button with the mapping to be cleaned up again.

d. Press the PS5/PS4 button /X1 button /NS Pro button  to exit the configuration mode.





For example, first press the button , and press the button  again, so that the button  is restored to the default function.

All clear







a. Simultaneously press the PS5/PS4 joystick buttons  and , the X1 joystick buttons  and  and the NS Pro joystick buttons  and  to enter the button position mapping function configuration mode.

b. Press the PS5/PS4 button /X1 button /NS Pro button  for three seconds, so that all configured button position mapping will be automatically cleaned up, and it will automatically exit the configuration mode.

4. Example 1



a. Firstly map the button  to the button , and then map the button  to the button , thus exchanging the two buttons.









(Under the button position mapping mode, the implementation method is to press the buttons in a sequence of )

b. Map the button  to the button , then map the button  to the button , and then map the button  to the button , thus exchanging the three buttons, and so on.

(Under the button position mapping mode, the implementation method is to press the buttons in a sequence of )



5. Example 2 (exchanging touch panel and SHARE)

a. In this configuration process, the PS5/PS4 button /X1 button /NS Pro button  can simulate other buttons by double click, so this operation shall be performed by the PS5/PS4 joystick or Pro joystick.

b. After entering the button position mapping function configuration mode, successively press the buttons     of the PS5/PS4 joystick, and the buttons     of the NS



Pro joystick, and then press the PS5/PS4 button /X1 button /NS Pro button  to exit the button position mapping function configuration mode.

6. Supported button positions













All buttons except for the PS5/PS4 button /X1 button /NS Pro button  and the rocking lever.

B. Running fire (defaulted as closed)













The running fire control is to configure the selected button as the running fire mode. When the button is in the running fire mode, after the button is pressed, it will simulate the press-release-press-release event at a certain frequency. The running fire frequency is adjustable.

PS: Press and hold the X1  button / NS handle  button / PS5/PS4 handle  button (handle vibration feedback) for 5 seconds before setting. Turn on the macro setting switch, if you open it before, you do not need to repeat this operation.









1. Start the running fire

- Simultaneously press the PS5/PS4 joystick buttons  and , X1 joystick buttons  and , and NS Pro joystick buttons  and , and release the buttons to enter the running fire function configuration mode.
- Press and hold the button requiring the running fire function to be on, and press the PS5/PS4 button /X1 button /NS Pro button  to start the running fire function of the corresponding button.
- Press the PS5/PS4 button /X1 button /NS Pro button  to exit the configuration mode.

2. Close the individual running fire











- Simultaneously press the PS5/PS4 joystick buttons  and , X1 joystick buttons  and , and the NS Pro joystick buttons  and , and release the buttons to enter the running fire function configuration mode.
- Press and hold the button requiring the running fire function to be off, and press the PS5/PS4 button /X1 button /NS Pro button  to close the running fire function of the corresponding button.
- Press the PS5/PS4 button /X1 button /NS Pro button  to exit the configuration mode.

3. Clear all running fire

- Simultaneously press the PS5/PS4 joystick buttons  and , X1 joystick buttons  and , and NS Pro joystick buttons  and , and release the buttons to enter the running fire function configuration mode.
- Press the PS5/PS4 button /X1 button /NS Pro button  for three seconds to automatically clear all configured running fire functions and to automatically exit the



























configuration mode.

4. Adjust the running fire frequency (basic mode)









- Simultaneously press the PS5/PS4 joypad buttons  and , X1 joypad buttons  and , and NS Pro joypad buttons  and , and release the buttons to enter the running fire function configuration mode.
- Press the button  to increase the running fire frequency.
- Press the button  to decrease the running fire frequency.
- Press the PS5/PS4 button /X1 button /NS Pro button .

5. Adjust the running fire frequency (defined mode)

In the custom mode, users can set two parameters: press time a millisecond and release time b millisecond. When the running fire is started, the press will be automatically pressed for a milliseconds and then released for b milliseconds and then pressed again for a milliseconds, thus moving in circle. The values of a and b shall be greater than 4 and less than 252.

- Determine the your desired value, for example, a is 128, and b is 164.
- Simultaneously press the PS5/PS4 joypad buttons  and , X1 joypad buttons  and , and NS Pro joypad buttons  and , and release the buttons to enter the running fire function configuration mode.
- Press the PS5/PS4 button /X1 button /NS Pro button  and PS5/PS4 button /X1 button , and hold the buttons.
- Set the value of a: press the button  to increase the value of a by 100; press the button  twice to increase the value of a by 20; and press the button  for eight times to increase the value of a by 8, which is totaled in 128.
- Set the value of b: press the button  to increase the value of b by 100; press the button  for six times to increase the value of b by 60; and press the button  for four times to increase the value of b by 4, which is totaled in 164.
- Release the PS5/PS4 button /X1 button /NS Pro button  and PS5/PS4 button /X1 button , and NS Pro button . If the configuration is normal, the red light will flicker.
- If the configuration is wrong in the process from step 2 to step 6, the reconfiguration can be carried out from the step 2. The value of a and the value of b can also be separately set.
- Press the PS5/PS4 button /X1 button /NS Pro button  to exit the configuration mode.



6. Supported button positions

All buttons except for the PS5/PS4 buttons   , X1 buttons    and NS Pro buttons    and the rocking lever.









C. One-button combo

In the fighting game, an ultimate skill is issued generally by continuously operating the joypad according to certain rule. The one-button combo function can record the combo action and can be set to be triggered by one button. After the setting is completed, the player can realize the









one-button combo.

PS: Press and hold the X1  button / NS handle  button / PS5/PS4 handle  button (handle vibration feedback) for 5 seconds before setting. Turn on the macro setting switch, if you open it before, you do not need to repeat this operation.









1. Setting

- a. Simultaneously press the PS5/PS4 joypad buttons  and , X1 joypad buttons  and , and NS Pro joypad buttons  and , and then release the buttons to enter the one-button combo function configuration mode.
- b. Perform the combo operation. The equipment will automatically record the combo (at most eight groups of combos can be recorded, each group of combos is at least recorded for five seconds, and the operation is not shielded).
- c. Press the PS5/PS4 button /X1 button /NS Pro button .
- d. Press the button for triggering the combo. After the setting succeeds, it will automatically exit the configuration mode.







2. Individual cleanup

- a. Simultaneously press the PS5/PS4 joypad buttons  and , the X1 joypad buttons  and  and NS Pro joypad buttons  and , and release the buttons to enter the one-button combo function configuration mode.
- b. Press the PS5/PS4 button /X1 button /NS Pro button .
- c. Press the button configured to trigger the combo. After succeeding in cleanup, it will automatically exit the configuration mode.

3. All clear

- a. Simultaneously press the PS5/PS4 joypad buttons  and , the X1 joypad buttons  and  and NS Pro joypad buttons  and , and release the buttons to enter the one-button combo function configuration mode.
- b. Press the PS5/PS4 button /X1 button /NS Pro button  for three seconds to automatically clear the configured one-button combo and to automatically exit the configuration mode.



4. Supported button position









All buttons except for the PS5/PS4 button /X1 button /NS Pro button  and the rocking lever can be used for triggering the one-button combo. All buttons except for the the PS5/PS4 button /X1 button /NS Pro button  can be used for recording.









D. Learning function (defaulted as closed)









This function can learn a set of operations of the player and can indefinitely circularly simulate this operation. The functions such as on-hook, favorable impression gaining, money gaining, etc. can be realized.

Note: when the learning function is used, if other functions are configured, it is required to continuously simulate the operation status after stopping the learning.

PS: Press and hold the X1  button / NS handle  button / PS5/PS4 handle  button (handle vibration feedback) for 5 seconds before setting. Turn on the macro setting switch, if you open it before, you do not need to repeat this operation.

1. Open the learning function (do not enter the configuration mode at the loop status)
 - a. Simultaneously press the PS5/PS4 joypad buttons  and , X1 joypad buttons  and , and NS Pro joypad buttons  and , and release the buttons to enter the learning function configuration mode.
 - b. Perform the operation to be learned. The equipment will automatically record this operation (it can record at most eight groups of operations, and each group of operations can be recorded for at least five seconds, and the operation cannot be shielded).
 - c. Press the PS5/PS4 button /X1 button /NS Pro button .
 - d. Press the button for triggering the learning function again. After succeeding in setting, it will automatically exit the configuration mode. (The triggering button is used to start and stop recorded the learning function).

2. Clear the individual learning function (do not enter the configuration mode at the loop status)
 - a. Simultaneously press the PS5/PS4 joypad buttons  and , X1 joypad buttons  and , and NS Pro joypad buttons  and , and release the buttons to enter the learning function configuration mode.
 - b. Press PS5/PS4 button /X1 button /NS Pro button .
 - c. Press the pre-configured button for triggering the learning function. After succeeding in clearing, it will automatically exit the configuration mode.

3. Clear all learning functions (do not enter the configuration mode at the loop status)
 - a. Simultaneously press the PS5/PS4 joypad buttons  and , X1 joypad buttons  and , and NS Pro joypad buttons  and , and release the buttons to enter the learning function configuration mode.
 - b. Press and hold the PS5/PS4 button /X1 button /NS Pro button  for three seconds to automatically clear all configured learning functions and to automatically exit the configuration mode.



4. Start/stop the learning function











- a. Press the button with set learning function to enter the status of indefinitely circulating this learning function.
- b. Press the button again to exit the status of indefinitely circulating this learning function.

5. Supported button positions

All buttons except for the buttons    of the PS5/PS4 joypad, the buttons    of the X1 joypad and the buttons    of the NS Pro joypad and the rocking lever.



E. joypad vibration switch and force adjustment function

PS: Press and hold the X1  button / NS handle  button / PS5/PS4 handle  button (handle vibration feedback) for 5 seconds before setting. Turn on the macro setting switch, if you open it before, you do not need to repeat this operation.







- Simultaneously press the PS5/PS4 joypad buttons  and , X1 joypad buttons  and  and NS Pro joypad buttons  and , and release the buttons to enter the vibration configuration mode.
 - Press  to increase the vibration force.
 - Press  to decrease the vibration force (when decreased to the lowest vibration force, the vibration is closed).
 - Press PS5/PS4 button /X1 button /NS Pro button  to exit the configuration mode.
- Note: DS3 joypad cannot adjust the vibration force and can only open and close the vibration.
-

F. Switch the four groups of independent configurations

It can simultaneously save four groups of configurations. When starting, the first group of configurations is defaulted to be loaded. The configurations in different groups do not interfere with one another.

PS: Press and hold the X1  button / NS handle  button / PS5/PS4 handle  button (handle vibration feedback) for 5 seconds before setting. Turn on the macro setting switch, if you open it before, you do not need to repeat this operation.







First group (default group)

PS5/PS4 joypad:  + ; X1 joypad:  + ; NS Pro:  + 







Second group

PS5/PS4 joypad:  + ; X1 joypad:  + ; NS Pro:  + 

Third group

PS5/PS4 joypad:  + ; X1 joypad:  + ; NS Pro:  + 

Fourth group



PS5/PS4 joypad:  + ; X1 joypad:  + ; NS Pro:  + 

Usage scenarios:

- The first group of configuration functions is default. Only the switching function of the joypad is used.
 - The second group is used for the jetting soldier 2 and for starting the running fire function and starting the one-button ultimate skill function.
 - The third group is used for Xenoblade 2 and for starting the one-button combo and button locking functions and for gaining the reputations, etc.
 - Other games
-

G. Start shooting - force gun







It can automatically force the gun after start the shooting. The force gun amplitude can be manually accurately adjusted.

PS: Press and hold the X1  button / NS handle  button / PS5/PS4 handle  button (handle vibration feedback) for 5 seconds before setting. Turn on the macro setting switch, if you open it before, you do not need to repeat this operation.







1. Start the start-shooting-force gun

Simultaneously press PS5/PS4 buttons  and , X1 buttons  and  and NS Pro buttons  and .





2. Use the start-shooting-force gun





After the start-shooting - force-gun is started, it is required to press the PS5/PS4 button , X1 button , and NS Pro button  (start-shooting button), then press the PS5/PS4 button , X1 button  and NS Pro button  (force gun button) to trigger the force gun effect.





3. Close the start-shooting - force gun (after the closing, there is no force gun effect)





Simultaneously press the PS5/PS4 buttons  and , X1 buttons  and  and NS Pro buttons  and .





4. Manually adjust the force gun amplitude

After the start-shooting force gun, the fixed force gun strength at every time is adjusted through the joystick buttons  and . The continuous increase amplitude of the force gun strength along with the lasting shooting time is adjusted through the buttons  and .

Press PS5/PS4 button , X1 button  and NS Pro button , and then press the button  to increase the fixed force gun strength at every time.



Press PS5/PS4 button , X1 button  and NS Pro button , and then press the button  to decrease the fixed force gun strength at every time.

Press PS5/PS4 button , X1 button  and NS Pro button , and then press the button  to increase the continuous increase amplitude of the force gun strength along with the lasting shooting time.







Press PS5/PS4 button , X1 button  and NS Pro button , and then press the button  to decrease the continuous increase amplitude of the force gun strength along with the lasting shooting time.

H. Force gun without start-shooting



It can realize the automatic force gun during the shooting without no start shooting. The force gun amplitude can be manually accurately adjusted.

PS: Press and hold the X1  button / NS handle  button / PS5/PS4 handle  button (handle vibration feedback) for 5 seconds before setting. Turn on the macro setting switch, if you open it before, you do not need to repeat this operation.







1. Start the non-start-shooting force gun

Simultaneously press the PS5/PS4 buttons  and , X1 buttons  and  and NS Pro buttons  and .





2. Use the non-start-shooting force gun





After starting the non-start-shooting force gun, directly press the PS5/PS4 button , X1 button  and NS Pro button  on the premise of no start-shooting to shoot. Thus can trigger the force gun effect.





3. Close the non-start-shooting force gun (after the function is closed, there is no force gun effect)





Simultaneously press the PS5/PS4 buttons  and , X1 buttons  and , and NS Pro buttons  and .





4. Manually adjust the force gun amplitude

Open the non-start-shooting force gun, adjust the fixed force gun strength through the buttons  and  of the joystick, and adjust the continuous increase amplitude of the force gun strength along with the lasting shooting time through the buttons  and .



Press PS5/PS4 button , X1 button  and NS Pro button , and then press the button  to increase the fixed force gun strength at every time.

Press PS5/PS4 button , X1 button  and NS Pro button , and then press the button  to decrease the fixed force gun strength at every time.

Press PS5/PS4 button , X1 button  and NS Pro button , and then press the button  to increase the continuous increase amplitude of the force gun strength along with the lasting shooting time.







Press PS5/PS4 button , X1 button  and NS Pro button , and then press the button  to decrease the continuous increase amplitude of the force gun strength along with the lasting shooting time.



I. Calibration function

PS: Press and hold the X1  button / NS handle  button / PS5/PS4 handle  button (handle vibration feedback) for 5 seconds before setting. Turn on the macro setting switch, if you open it before, you do not need to repeat this operation.

The calibration function can solve the joystick drift problem of some handles without increasing the dead zone.

1. Calibrate the joystick:

a. Simultaneously press the PS5/PS4 controller  +  button; X1 controller  +  button; NS Pro controller  +  button and release to enter the calibration configuration mode. (Handle vibration feedback)

b. Press the  button on the PS5/PS4 controller;  button on the X1 controller;  button on the NS Pro controller. (Handle vibration feedback)

c. After stopping the vibration, wait for 1 second and automatically exit the calibration mode.

Recommendations:

Most original handles do not need to be calibrated. If there is a joypad drift, it is recommended to calibrate first.